



## MODEL 61501/61502/61503/ 61504/61505

### KEY FEATURES

- Output Rating :
  - Power : 500VA (61501), 1000VA (61502)
  - 1500VA (61503), 2000VA (61504)
  - 4000VA (61505)
- Voltage range: 0-150V/0-300V/Auto
- Compact size and weight attributable to advance PWM technology
- AC+DC output mode for voltage DC offset simulation
- Programmable slew rate setting for changing voltage and frequency
- Low output impedance for testing IEC 61000-3-2 ( 61505 )
- Programmable output impedance for testing IEC 61000-3-3
- LIST, PULSE, STEP mode function for testing power line disturbance (PLD) simulation capability
- IEC 61000-4-11 voltage dips, short and variation simulation
- Harmonics, inter-harmonics waveform synthesizer for testing IEC 61000-4-13
- Programmable voltage, current limit
- Comprehensive measurement capability, including current harmonics
- High output current crest factor, ideal for inrush current testing
- Turn on, turn off phase angle control
- TTL signal which indicates output transient
- Analog programmable interface
- 3 units combined to 3-phase power output
- Easy-use software for operation and IEC regulation test
- Optional RS-232, GPIB, LAN, and USB interfaces

## PROGRAMMABLE AC POWER SOURCE MODEL 61501/61502/61503/61504/61505

Chroma AC power source 61500 series sets up the new standard for high performance AC power source. It equips with all powerful features such as power line disturbance (PLD) simulation, programmable output impedance, comprehensive measurement functions, wave-shape synthesis and regulation test software. These features make the 61500 series ideal for commercial, power electronics, avionics, military and regulation test applications from bench-top testing to mass production.

Line up from 500VA to 4000VA with one phase output, the 61500 series give users the maximum choices from R/D design verification, quality assurance, to production test.

Using the state-of-the art PWM technology, the 61500 series is capable of delivering up to 6 times of peak current compared to its maximum rated current that makes it ideal for inrush current test.

The AC+DC modes extend the applications not only pure AC voltage but also DC component for testing DC offset in laboratory. Applying the advanced DSP technology, the 61500 series is able to provide precision

and transient voltage waveform as well as measurements such as RMS voltage, RMS current, true power, power factor, current crest factor and up to 40 orders of current harmonic components.

The 61500 series allows users to compose different harmonic components to synthesize their own harmonic distorted wave-shapes. To simulate the natural waveform, the 61500 series also provides an external analog input to amplify the analog signal from arbitrary signal generator. Thus, it is capable of simulating the unique waveform observed in the field.

With the versatile programmable voltage functions and easy-use operation software, the 61500 series enables users to perform the pre-compliance tests against IEC 61000-4-11 and compliance test against IEC 61000-4-13/-4-14/-4-28 immunity test regulations. With low impedance and low voltage harmonic character, model 61505 can be a standard source for 230V/16A IEC 61000-3-2 testing. With programmable output impedance function, 61500 series provide a solution for testing IEC 61000-3-3 regulations by incorporating a flicker meter.



**Chroma**

## Advanced PWM Technology

Chroma AC power source 61500 series is able to provide the highest power density by its superior PWM mode design and the incorporated power factor correction function.



## AC/ DC output Capability

Chroma AC power source 61500 series provide output DC component for simulating AC voltage with DC offset condition. It can test the unbalance input current for rectified load. Users also can use an optional DC noise filter to get low noise and good stability DC voltage for testing.

## Comprehensive Measurements

Chroma AC power source 61500 series has built in a 16-bit measurement circuit and firmware utilities to measure the steady and transient responses of true RMS voltage, current, true power, VA(apparent power), VAR(reactive power), power factor, current crest factor, peak repetitive current and inrush current. Using the advanced DSP technology, it can measure up to 40 orders of current harmonics. It makes 61500 series not only a power source but also a powerful analyzer.

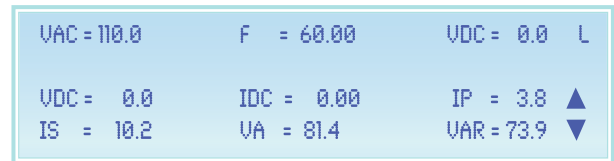
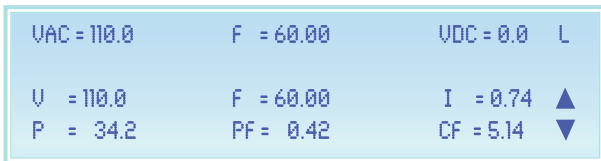

## Power Line Disturbance Simulation

In addition to the steady output voltage and frequency programming, Chroma AC power source 61500 series provides powerful functions to simulate all kinds of power line disturbance conditions. The STEP and PULSE modes offer an easy and convenient method to execute a single step or continuous output changes. The changes may be triggered by an internal or external event. With this capability, it is easy to simulate power line disturbances such as cycle dropout, transient spike, brown out and etc.

The LIST Mode extends this function for more complex waveform generator needs. Up to 100 sequences with different start-end conditions, that can perform almost any waveform by AC and DC components. It also allows users to synchronize external events as well as measurement devices with output changes

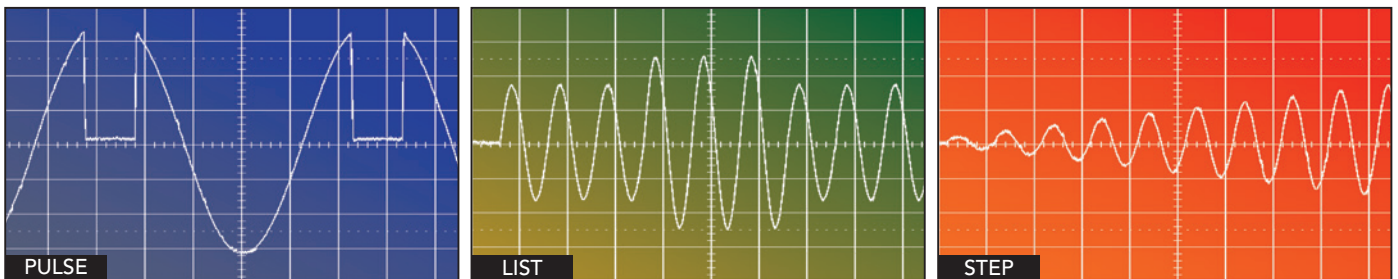

## Programmable Output Impedance

Chroma AC source 61500 series allows users to program output impedance. A current feedback control circuit makes the output voltage changed with the load. This feature is suitable for IEC 61000-3-3 Flicker tests or other test condition with particular output impedance requirement. It provides users a convenient and cost effective way to implement the reference impedance.

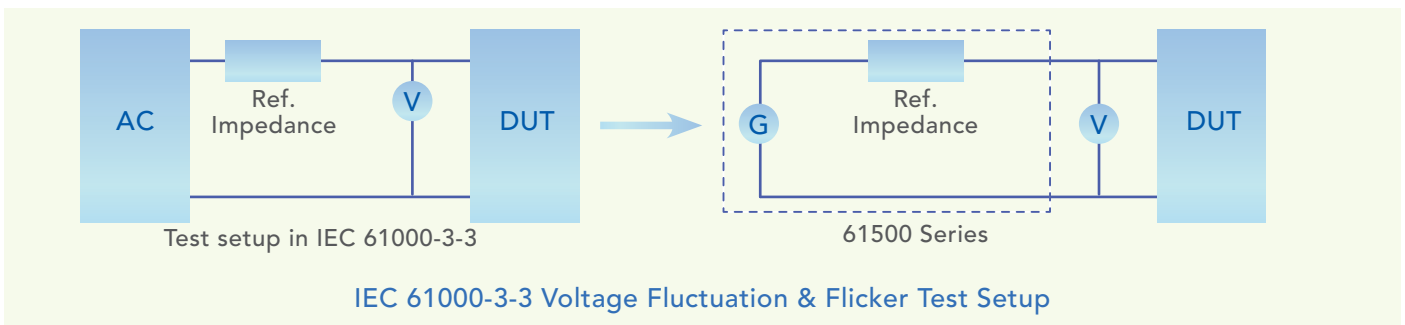

## Arbitrary Power Amplifier

The external voltage programming input of Chroma AC power source 61500 series allows users to feed any AC+DC waveform from an arbitrary signal generator. And amplify the signal accordingly. It can be used to simulate the real mains supply waveforms observed in the field.

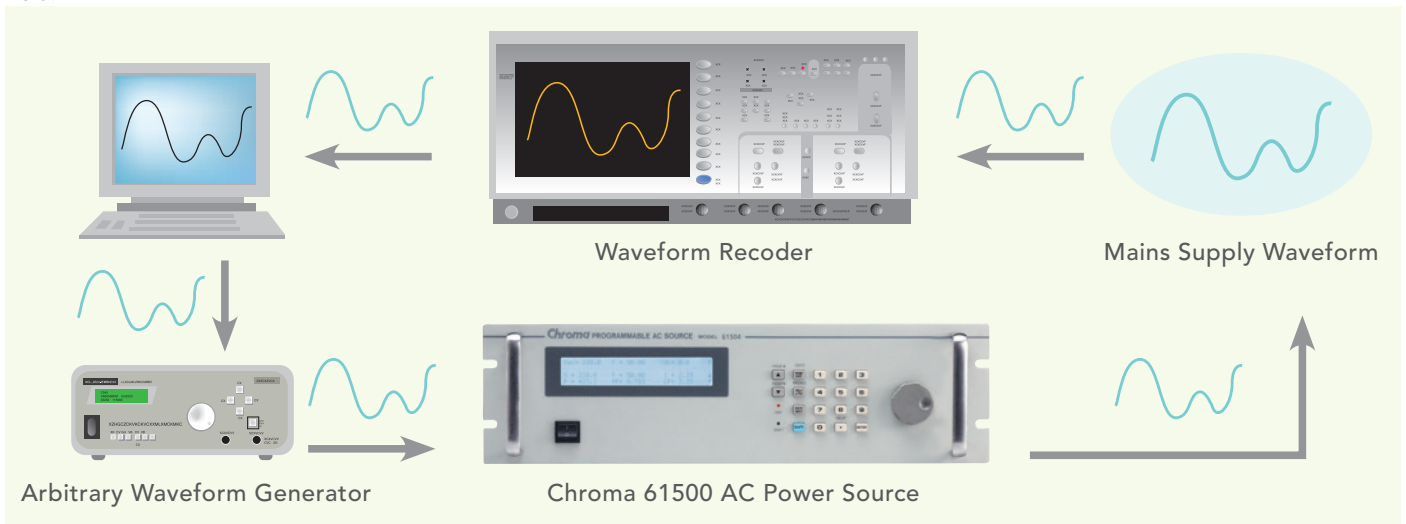

## High Output Current Crest Factor and Turn On / Off Phase Angle Control

Chroma AC power source 61500 series is capable of providing high output current crest factor (Max. 6). It delivers sufficient transient power required for testing most of the rectified input type power circuits. The programmable turn on (off) phase angle control makes the 61500 series AC source ideal for inrush current test.

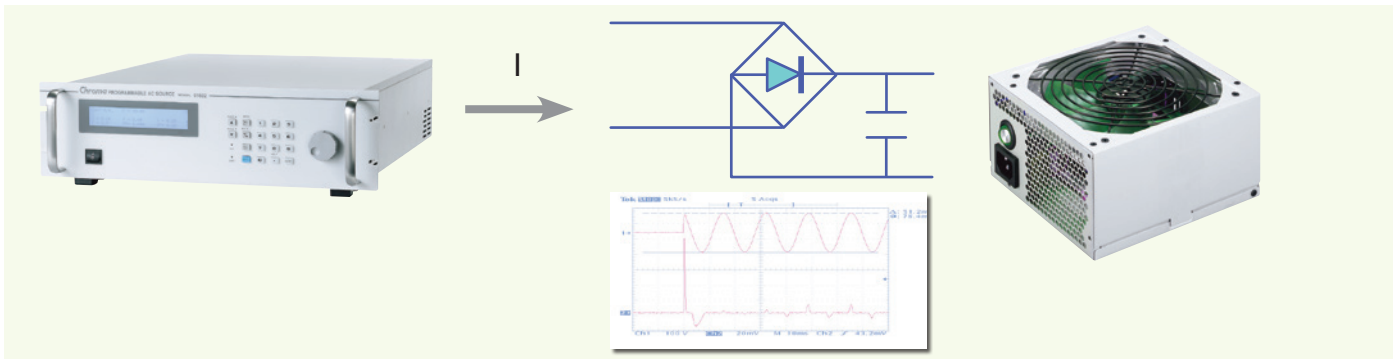

## Voltage Dips and Variation Simulation

IEC 61000-4-11 voltage dips, short interruption and variation standard have become mandatory in EMC directives for the CE mark. Chroma AC power source 61500 series is capable of simulating all sorts of voltage dips, interruptions and variation waveforms for IEC 61000-4-11 pre-compliance tests with an easy-use software.

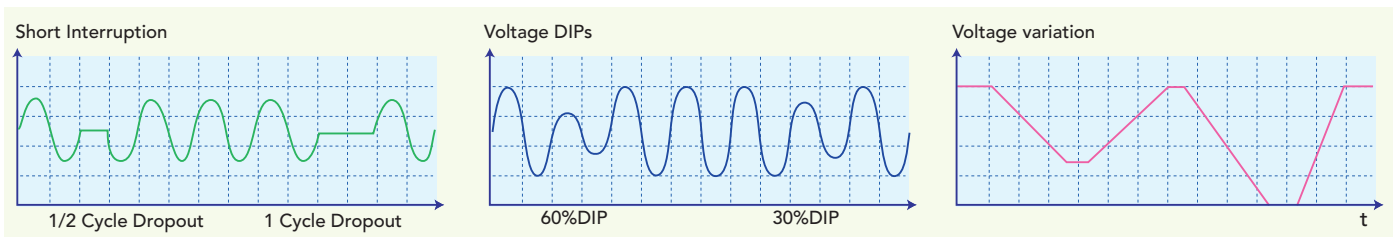

## Harmonics, Interharmonics Synthesis

Traditional type of AC source only allows users to composite integer orders of harmonic components into a periodic harmonics distortion waveform. IEC 61000-4-13 standard requires not only the harmonics waveform, but also interharmonics simulation. This means the fundamental frequency will incorporate with components frequencies between harmonics frequencies. Chroma AC power source 61500 series uses advanced DSP technology to synthesis the harmonics and interharmonics waveforms. Therefore, it is capable of generating a non-periodic harmonic distorted waveform to perform IEC 61000-4-13 compliance test with an easy-use software.

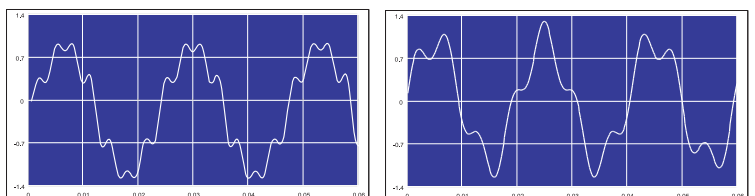

## APPLICATIONS

### Simulate AC Power Distortion

More and more electronics manufactures have expanded their business to acquire worldwide product distribution. When a problem is identified, sometimes it is necessary to check if the products are susceptible to ac line disturbances. However, precious time would be wasted on gathering and transferring test equipment, man power and other resources to do a simple onsite test. The purpose of this application is to provide a solution using Chroma Digital Power Meter 66200 Series to measure the voltage harmonics of the ac main on site. All recorded data can be sent to the lab. According to the data, users can use synthesis function of AC source 61500 series to re-build the original distorted waveform. It can help engineers quickly point out the problem and come up with a solution.

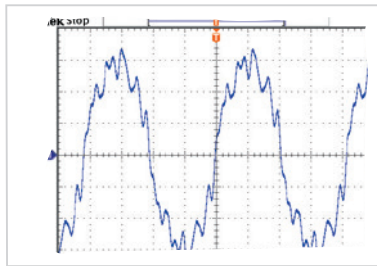
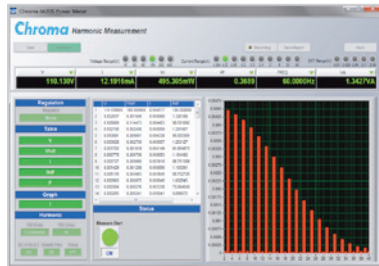

Re-build Distortion Waveform

### The easy-use software : The 61500 Series Softpanel

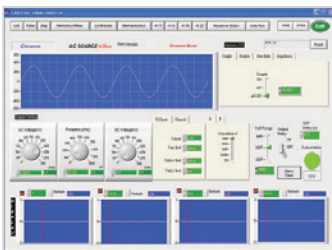

Main Operation Menu

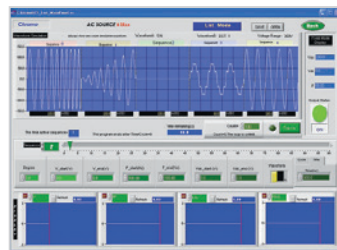

Transient Voltage Programming



Distorted Waveform Editor



Recording for Long Time Measurement



Voltage DIP, Short, Variation Regulation Test



Frequency Variation Test



Voltage Fluctuation Test

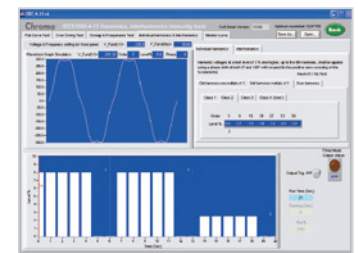

Voltage Harmonic & Interharmonics Test

### 3-Phase Mode and Series Connecting for High Voltage Output

The 61500 series AC source provides a 3-PHASE mode to let users connect 3 units for 3-phase output application. Users can set a unit as the Master, and set others the phase angle 120/240 degree as the Slaves. The Master unit will keep on Fixed mode and send a signal for synchronizing Slaves. Now, more and more UUTs need to test AC line transient with high voltage > 300V. An external boost transformer might raise the voltage, but the serious loading effect will make the voltage waveform with large distortion. Users can connect 2 units of 61500 in series and set the phase angle to zero (see figure) in 3-PHASE mode. In this way, users can program a 220V/0.5sec superimposed on 230V to get a 450V transient voltage easily.

### 3-Phase output application



### 2 Units in series application

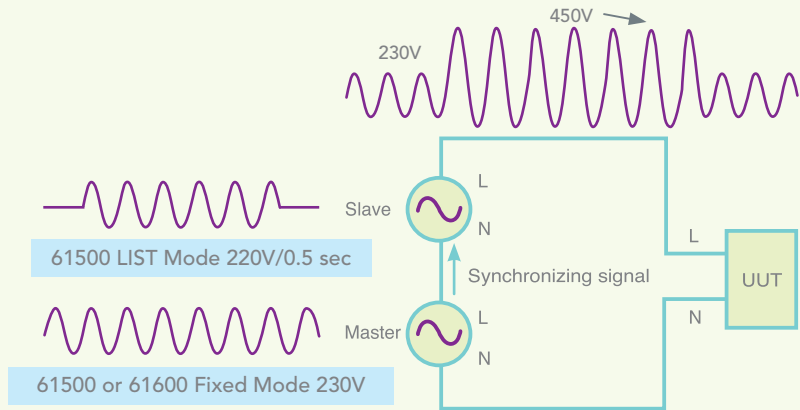

### PANEL DESCRIPTION

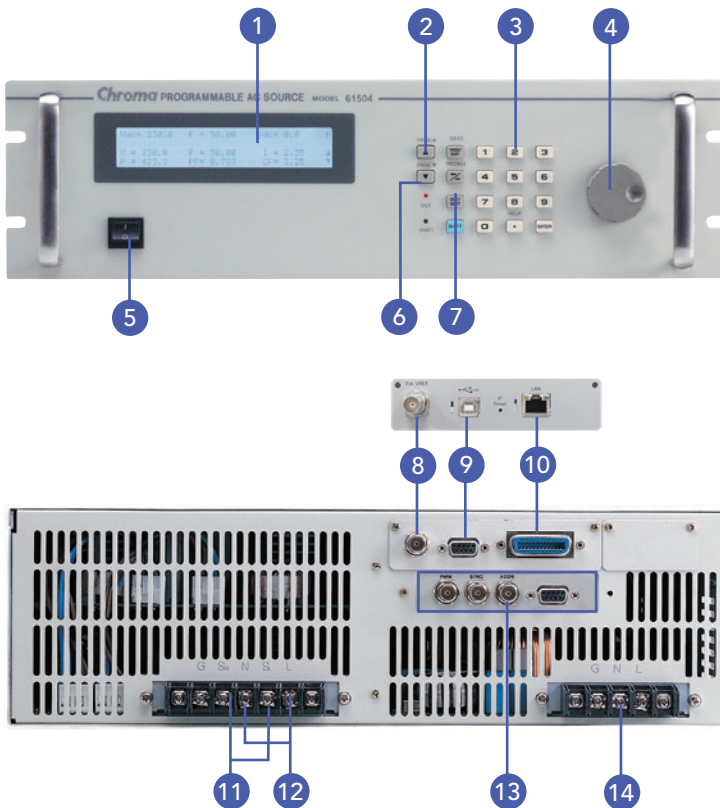

1. **LCD Display**  
Show the test setup, operating status and readings
2. **Page Up/Down Key**  
Facilitate parameter data editing
3. **Numeric Key**  
Data entry for test parameters
4. **Rotary Knob**  
Regulate for voltage, frequency and parameter setting
5. **Power Switch**
6. **Output Indicator**  
Lighten when output is enable
7. **Output Enable Key**  
Enable or disable output
8. **External V Reference**  
External programming voltage input
9. **RS-232 or USB Interface (alternative option)**
10. **GPIB or LAN Interface (alternative option)**
11. **Remote Sense Terminal**  
Use to compensate the line drop between source and testing point
12. **Output Terminal**  
Connect output cable to the UUT
13. **System Interface**  
For synchronizing signal and transient signal
14. **Input Terminal**

### ORDERING INFORMATION

61501 : Programmable AC Source 0~300V, 15~1kHz / 500VA, 1Ø  
 61502 : Programmable AC Source 0~300V, 15~1kHz / 1kVA, 1Ø  
 61503 : Programmable AC Source 0~300V, 15~1kHz / 1.5kVA, 1Ø  
 61504 : Programmable AC Source 0~300V, 15~1kHz / 2kVA, 1Ø  
 61505 : Programmable AC Source 0~300V, 15~1kHz / 4kVA, 1Ø  
 A615001 : Remote interface for 61501~61505 and 61601~61605  
 (External V Input, RS-232 interface, GPIB interface)

A615002 : Remote interface board (LAN and USB) for model 61500/61600/61700 series  
 A615003 : AC voltage transform unit for model 61500/61600 series  
 A615007 : Softpanel for model 61500/61600 series  
 A615008 : DC noise filter (max. 16A)  
 \* Support higher than 300V output voltage capability, please contact Chroma sales representative for detailed information.

## SPECIFICATIONS

Model	61501	61502	61503	61504	61505
Output Phase	1	1	1	1	1
Output Rating -AC					
Power	500VA	1000VA	1500VA	2000VA	4000VA
Voltage					
Range/Phase	150V/300V/Auto	150V/300V/Auto	150V/300V/Auto	150V/300V/Auto	150V/300V/Auto
Accuracy	0.2%+0.2%F.S.	0.2%+0.2%F.S.	0.2%+0.2%F.S.	0.2%+0.2%F.S.	0.2%+0.2%F.S.
Resolution	0.1V	0.1V	0.1V	0.1V	0.1V
Distortion*1	0.3% @ 50/60Hz 1% @ 15-1kHz (Typical)	0.3% @ 50/60Hz 1% @ 15-1kHz (Typical)	0.3% @ 50/60Hz 1% @ 15-1kHz (Typical)	0.3% @ 50/60Hz 1% @ 15-1kHz (Typical)	0.3% @ 50/60Hz 1% @ 15-1kHz (Typical)
Line Regulation	0.1%	0.1%	0.1%	0.1%	0.1%
Load Regulation*2	0.2%	0.2%	0.2%	0.2%	0.2%
Max. Current					
R.m.s.	4A/2A (150V/300V)	8A/4A (150V/300V)	12A/6A (150V/300V)	16A/8A (150V/300V)	32A/20A (150V/300V)
Peak	24A/12A (150V/300V)	48A/24A (150V/300V)	72A/36A (150V/300V)	96A/48A (150V/300V)	192A/96A (150V/300V)
Frequency					
Range	DC, 15 ~ 1kHz	DC, 15 ~ 1kHz	DC, 15 ~ 1kHz	DC, 15 ~ 1kHz	DC, 15 ~ 1kHz
Accuracy	0.15%	0.15%	0.15%	0.15%	0.15%
Output Rating-DC					
Power	250W	500W	750W	1000W	2000W
Voltage	212V/424V	212V/424V	212V/424V	212V/424V	212V/424V
Current	2A/1A (212V/424V)	4A/2A (212V/424V)	6A/3A (212V/424V)	8A/4A (212V/424V)	16A/8A (212V/424V)
Programmable Output Impedance					
Range	0Ω +200μH ~ 1Ω +1mH				
Harmonics & Inter-harmonics Simulation					
Bandwidth	2400Hz	2400Hz	2400Hz	2400Hz	2400Hz
Input Rating					
Voltage Range	1Ø 100~240V ± 10%V <sub>LN</sub>	1Ø 100~240V ± 10%V <sub>LN</sub>	1Ø 100~240V ± 10%V <sub>LN</sub>	1Ø 100~240V ± 10%V <sub>LN</sub>	3Ø 200~240V ± 10%V <sub>LN</sub>
Frequency Range	47~63Hz	47~63Hz	47~63Hz	47~63Hz	47~63Hz
Current (per phase)	10A Max. @ 90V	18A Max. @ 90V	22A Max. @ 90V	28A Max. @ 90V	14A Max. @ 190V
Power Factor*4	0.97 Min.	0.97 Min.	0.98 Min.	0.98 Min.	0.98 Min.
Measurement					
Voltage					
Range	150V/300V	150V/300V	150V/300V	150V/300V	150V/300V
Accuracy	0.2%+0.2%F.S.	0.2%+0.2%F.S.	0.2%+0.2%F.S.	0.2%+0.2%F.S.	0.2%+0.2%F.S.
Resolution	0.1V	0.1V	0.1V	0.1V	0.1V
Current					
Range (peak)	24A	48A	72A	96A	192A
Accuracy (r.m.s.)	0.4%+0.3%F.S.	0.4%+0.3%F.S.	0.4%+0.3%F.S.	0.4%+0.3%F.S.	0.4%+0.3%F.S.
Accuracy (peak)	0.4%+0.6%F.S.	0.4%+0.6%F.S.	0.4%+0.6%F.S.	0.4%+0.6%F.S.	0.4%+0.6%F.S.
Power					
Accuracy	0.4%+0.4%F.S.	0.4%+0.4%F.S.	0.4%+0.4%F.S.	0.4%+0.4%F.S.	0.4%+0.4%F.S.
Resolution	0.1W	0.1W	0.1W	0.1W	0.1W
Harmonics					
Range	2~40 orders	2~40 orders	2~40 orders	2~40 orders	2~40 orders
Others					
Interface	USB, LAN, GPIB, RS-232 (optional)				
Temperature					
Operating	0 ~ 40°C	0 ~ 40°C	0 ~ 40°C	0 ~ 40°C	0 ~ 40°C
Storage	-40 ~ +85°C	-40 ~ +85°C	-40 ~ +85°C	-40 ~ +85°C	-40 ~ +85°C
Safety & EMC	CE ( include EMC & LVD )				
Dimensions (HxWxD)	133.35x82.6x569.5mm/ 5.25x19x22.42 inch	133.35x482.6x569.5mm/ 5.25x19x22.42 inch	133.35x482.6x569.5mm/ 5.25x19x22.42 inch	133.35x482.6x569.5mm/ 5.25x19x22.42 inch	266.7x482.6x569.5mm/ 10.5x19x22.42 inch
Weight	20 kg / 44.05 lbs	20 kg / 44.05 lbs	20 kg / 44.05 lbs	20 kg / 44.05 lbs	41 kg / 90.31 lbs

Note\*1 : Maximum distortion is tested on output 125VAC (150V RANGE) and 250VAC (300V RANGE) with maximum current to linear load.

Note\*2 : Load regulation is tested with sine wave and remote sense.

Note\*3 : Model 61505 can also use single-phase connecting method of input AC power, the maximum input current is 28A @ 190V.

Note\*4 : Input power factor is tested on input 220V, full load condition.

Get more product & global distributor information in Chroma ATE APP



iOS



Android

Search Keyword

61505

HEADQUARTERS  
CHROMA ATE INC.  
88 Wenmao Rd.,  
Guishan Dist.,  
Taoyuan City  
333001, Taiwan  
T +886-3-327-9999  
F +886-3-327-8898  
www.chromaate.com  
info@chromaate.com

U.S.A.  
CHROMA SYSTEMS  
SOLUTIONS, INC.  
19772 Pauling,  
Foothill Ranch,  
CA 92610  
T +1-949-600-6400  
F +1-949-600-6401  
www.chromausa.com  
sales@chromausa.com

EUROPE  
CHROMA ATE EUROPE B.V.  
Morsestraat 32, 6716 AH  
Ede, The Netherlands  
T +31-318-648282  
F +31-318-648288  
www.chroma.eu.com  
salesnl@chroma.eu.com  
  
CHROMA GERMANY GMBH  
Südtiroler Str. 9, 86165,  
Augsburg, Germany  
T +49-821-790967-0  
F +49-821-790967-600  
www.chroma.eu.com  
salesde@chroma.eu.com

JAPAN  
CHROMA JAPAN  
CORP.  
888 Nippa-cho,  
Kouhoku-ku,  
Yokohama-shi,  
Kanagawa,  
223-0057 Japan  
T +81-45-542-1118  
F +81-45-542-1080  
www.chroma.co.jp  
info@chroma.co.jp

KOREA  
CHROMA ATE  
KOREA BRANCH  
3F Rightogether  
Center, 14,  
Pangyojeok-ro 192,  
Bundang-gu,  
Seongnam-si,  
Gyeonggi-do  
13524, Korea  
T +82-31-781-1025  
F +82-31-8017-6614  
www.chromaate.co.kr  
info@chromaate.com

CHINA  
CHROMA ELECTRONICS  
(SHENZHEN) CO., LTD.  
8F, No.4, Nanyou Tian  
An Industrial Estate,  
Shenzhen, China  
T +86-755-2664-4598  
F +86-755-2641-9620  
www.chroma.com.cn  
info@chromaate.com

SOUTHEAST ASIA  
QUANTEL PTE LTD.  
(A company of Chroma Group)  
25 Kallang Avenue #05-02  
Singapore 339416  
T +65-6745-3200  
F +65-6745-9764  
www.quantel-global.com  
sales@quantel-global.com